

Growing Gardeners Program

# Vegetable Gardening

**Handbook for Beginners**



UC Master Gardener Program of Contra Costa County  
*Advice to Grow By*

*[This Page Intentionally Left Blank]*

The UC Master Gardener Program is a public service and outreach program under the University of California Division of Agriculture and Natural Resources, administered locally by participating UC Cooperative Extension county offices. Since 1981, the University of California Master Gardener Program has been extending UC research-based information about home horticulture and pest management to the public.

*“To extend research-based knowledge and information on home horticulture, pest management, and sustainable landscape practices to the residents of California and be guided by our core values and strategic initiatives.”*

*- UC Master Gardener Program Mission Statement*



*The Growing Gardeners Program helps beginner gardeners start their own gardens quickly and easily in a container, in the backyard, or at a community garden*

# Vegetable Gardening Handbook for Beginners

*UC Master Gardener Program of  
Contra Costa County  
Growing Gardeners Program*

Program Coordinator: Darlene DeRose,  
UC Master Gardener, Contra Costa County

*University of California Cooperative Extension  
2380 Bisso Lane, Suite B  
Concord, CA 94520  
<http://ccmg.ucanr.edu>*

*Adapted from the original UCCE-Los Angeles County version  
by Yvonne Savio and Valerie Borel  
Rachel Surls, Ph.D., editor*

October 2018

## History of the Project

The Growing Gardeners Program was adapted from the Grow L.A. Victory Garden Initiative, a program of the UC Master Gardener Program of Los Angeles County, which was started in 2010 to support beginning gardeners. The initial project in L.A. was named after the World War II-era Victory Garden movement, which rallied the country around home food production to enhance national security. Food matters just as much, if not more, today.

Research shows that eating more vegetables improves health, reduces obesity, and cuts down on the risk of chronic diseases such as diabetes and cancer. Having a garden helps save on grocery bills when economic times are tough. A vegetable garden can be planted in a backyard, in pots on a balcony, or in a community garden. Gardening is easy once you get the hang of it, but beginning gardeners may need some extra attention and support the first time out.

This Handbook is a companion piece for classes being conducted by the UC Master Gardener volunteers in communities around Contra Costa County. We are indebted to Rachel Surls, Ph.D. and the UC Master Gardener Program of Los Angeles County for allowing us to adopt, and adapt, this Handbook for use in Contra Costa County.

# Table of Contents

<b>Planning your Garden</b>	<b>1</b>
<i>Site selection</i>	1
<i>Raised beds</i>	2
<i>Growing vegetables in containers</i>	3
<i>Plant selection</i>	7
<b>Getting Started</b>	<b>11</b>
<i>Soil preparation</i>	11
<i>Seed starting</i>	16
<i>Transplanting</i>	17
<i>Composting</i>	18
<i>Wise water use</i>	22
<b>Pest Management</b>	<b>23</b>
<i>Pests in the garden</i>	23
<i>Beneficial insects and other biological controls</i>	25
<i>Pest triangle</i>	26
<i>Weeds</i>	26
<i>Diseases</i>	27
<i>Insects</i>	28
<b>Harvesting</b>	<b>29</b>
<i>Food safety in your home vegetable garden</i>	29
<b>Appendix</b>	<b>31</b>
<i>Principal Parts of a Vascular Plant</i>	31
<i>Principal Parts of a Flower</i>	32
<i>Garden Chemicals; Safe Use &amp; Disposal</i>	33
<b>Resources</b>	<b>35</b>

*[This Page Intentionally Left Blank]*



# Planning your Garden

## Site selection



*Raised vegetable beds in a garden setting. U.C. Agriculture and Natural Resources photograph*

Growing vegetables in your home or garden is good for you, your neighborhood, and for helping to reduce your carbon footprint. Growing vegetables at home can be done in a single pot on your patio or on a larger scale depending upon the space and time you have available. Choose the best site for your garden, preferably in a location that is easily accessible from your home.

- The size of your garden will be dependent upon available space, the time you have to garden and the food needs of your family and neighborhood.

- Make a map of the proposed area using grid paper and drawing it to scale.
- Make sure the site receives 6 to 8 hours of direct sun per day.
- Full sun is ideal for all vegetables.
- Root and leafy crops (carrots, turnips, beets, leaf lettuce, spinach, etc.) can tolerate some shade.
- Insufficient sunlight can increase disease problems when growing many plants.
- Put tall and trellised plants on the north side so that they don't cast shade on the shorter plants.
- Make sure there is an adequate and handy water source near your garden.
- Select a level area with well-drained soil.
- Soil can be amended with compost or other organic matter to improve quality for greater yields.
- Determine plant spacing by the size of the mature plant - their leaves should just be touching.
- Most vegetables can be planted over a long range of dates.
- Plant new crops once you've harvested the first ones.

If there isn't enough room at home for a vegetable garden, consider joining a community garden to grow your vegetables. Community gardens can be found easily throughout the county. To find a garden in your community, please visit our website

<http://ccmg.ucanr.edu/CommunityGardens/CurrentCommunityGardens>

## Raised beds

- Easy to maintain without stepping on loose soil reserved for plant roots
- Keeps amended soil separate from pathways and unamended soil
- Pest control is easier - snails, gophers and two-legged critters
- Crop rotation is easier
- Ownership of bed is defined in a community or school garden
- Easy access for seniors and physically challenged persons

Bed depth should be at least twelve inches, or up to 3 feet tall to provide for tomato roots. In order to access the bed from both sides, the width of a raised bed should not be more than about four feet. If you only have access from one side, make the bed no wider than three feet.

Raised beds planted intensively and well-amended with manure and compost between crops offer higher yields in less space and are easier to keep weed free. Raised beds allow for early- and later-season planting because the soil warms earlier in the spring and stays warm longer in the fall. Beds can be covered easily with floating row covers to protect crops from pests, frost or summer light intensity. Build a reinforced or "boxed" raised bed using 2x12 redwood planks for the sides and ends. Fill with amended soil. If you are purchasing "soil," be cautious because there is no legal definition of topsoil, garden soil, etc.



*Lettuce growing in a raised bed vegetable garden*

Be sure to look at the material before you purchase it. Do not use just any garden soil because you may be importing diseases, weeds and pests. Amend with 1/3 part each compost and manure. Clumps of compost or clods of soil must be broken up and uniformly mixed together. A permanent sprinkler system or a faucet for irrigation hoses can be attached to the outside of the raised bed.

# Growing vegetables in containers

There are seven major considerations in container gardening:

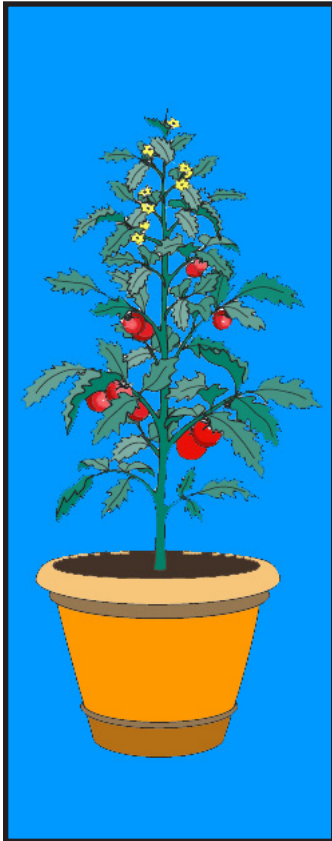

## 1. How much sun is available?

Choose plants according to how much sun or shade they'll get each day. Most vegetables need at least 6 to 8 hours of direct sun every day. Leafy vegetables, such as lettuce, onions, carrots and beets will do okay in partial shade. But plants that bear fruit such as tomatoes, eggplant, squash, peppers need more than 8 hours of full sun.

## 2. What type of container?

Almost any container will do as long as it has good drainage. Smaller containers and unglazed clay pots dry out very quickly in summer. The smallest for outdoor use is probably 8 to 12 inches in diameter and depth. In part shade, you may have success with smaller containers.

If you are using recycled containers, scrub them well and rinse in a solution of 9 parts water to one part bleach. If containers are porous (clay, wood, cement) soak them well in water before filling so they won't act like sponges and pull all the water out of your soil.

A deeper container is always better than a wider container because it provides more space for the roots to grow down in search of moisture and cooler temperatures. This will enable plants to thrive during hot summers when more frequent irrigation is required. Containers should be at least 4"

deeper than the the length the roots will reach at maturity.

Since plants in containers are above ground, the roots are more sensitive to temperature extremes. Midsummer heat can kill tiny hair-like feeder roots. Without these feeder roots, the plant will wilt even if the soil is wet. Then larger roots become very susceptible to root rot fungus that can destroy the rest of the plant. Overheating of the soil is a common cause of failure in container plantings. Thick wood insulates best, dark-colored containers will absorb more heat, and light-colored containers reflect heat.

## 3. What should you plant?

Shallow-rooted crops like herbs, lettuce, green onions, radishes and spinach are easy to grow. Carrots, potatoes, turnips and other roots crops need much deeper containers. Tall or sprawling vegetables (eggplant, peppers, squash and tomatoes) have extensive root systems. They will bear well if they have enough room for roots to develop. To get the most out of your limited space, choose high yielding and dwarf varieties with small-to-moderate sized fruit. These include beans, beets, carrots, lettuce, peppers, radishes and some varieties of summer squash and tomatoes. Stay

away from varieties labeled “whopper”. Look for short, bushy, rather than tall, vining plants. For the highest yield, provide support for vining or trailing crops and add the stakes or trellis when you first plant the seeds or transplants so that you won’t damage roots by adding them at a later date.

**4. Seeds or transplants?**

Plant beans, beets, carrots, cucumbers, lettuce, peas, radishes and squash from seed. Eggplant, peppers, and tomatoes are best purchased as transplants. Buy the smallest size available (6 packs or 4” pots), since they will develop better roots and grow to larger sizes more quickly than the gallon size plants can acclimate to the location.

**5. Preparation of the soil**

Do not use garden soil. It may contain diseases and fungi and is usually very heavy and slow to drain. Buy a high quality soil mix that is sterilized and able to absorb moisture and drain quickly.

**6. Fertilizing**

Plants “trapped” in containers cannot search for nutrients or water. Confined root systems demand frequent but light fertilizing during their growing period. Nutrients are leached from the soil with every watering and need to be replenished regularly. Two to four weeks after planting, begin applying a water soluble fertilizer (mixed one-quarter strength) with each watering. Organic gardeners can use liquid fish emulsion, liquid kelp or blood or bone meal. The three numbers on the fertilizer package - such as 10-10-10 - explain what the fertilizer is formulated to do. The numbers are always in the following order:

- Nitrogen - for green leaves
- Phosphorus - for flowers and fruit
- Potassium - for root growth

When one of the numbers is higher than the others, that means the fertilizer is designed to promote more growth in that specific part of the plant. Do not overfeed. A little is good, a lot is NOT better!

How deep should the container be? How far apart the plants?		
These are good for low planting boxes		
PLANT	SPACING	SOIL DEPTH
Beets	3” apart	9” to 12”
Leaf Lettuce	6” apart	9” to 12”
Onions	3” apart	9” to 12”
Radishes	1” to 2” apart	9” to 12”
Spinach	5” apart	9” to 12”
Swiss Chard	6” apart	9” to 12”
These need moderate depth		
PLANT	SPACING	SOIL DEPTH
Broccoli	12” apart	12” to 14”
Cabbage	12” apart	12” to 14”
Cauliflower	12” apart	12” to 14”
Cherry Tomatoes	12” apart	14” to 16”
Eggplant	12” apart	14” to 16”
Peas	3” apart	14” to 16”
Peppers	12” apart	14” to 16”
Carrots	2” apart	9” to 18” (dep. on carrot length)
These are the deep ones:		
PLANT	SPACING	SOIL DEPTH
Beans	5” apart	16” to 18”
Cucumbers	12” apart	16” to 18”
Potatoes	6” apart	16” to 18”
Summer Squash	18” apart	16” to 18”
Tomates	18” apart	16” to 18”

## **7. Watering requirements**

All containers dry out quickly. Watering requirements will vary according to the season, type of container, soil mix and sun exposure. Check containers daily. Stick your finger into the top inch of soil. If it feels damp there is no immediate need for water. If it feels dry, water until some runs out the bottom of the container. In mid-summer and on windy days this may be needed daily. In summer, provide a saucer that can fill with the excess water and then be reabsorbed as needed. In winter, remove the saucer so the plants don't sit in water and stagnate.









Water early in the morning to avoid wet leaves at night when temperatures drop and mildew and disease organisms flourish. Use a slow even spray to avoid washing out the soil.

## **8. Mulching**

Mulch plants with straw or other non-woody material from June through the summer. It will reduce evaporation, save water, and plants grow better without struggling.

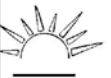
### WHAT TO GROW IN CONTAINERS

Starting a container garden doesn't mean you'll have to limit the varieties of plants you grow. Listed below are flowers, vegetables and herbs that do well in containers. The species are coded for quick reference to life span, cultural requirements and recommended Containers.

(A) - Annual (B) - Biennial (C) - Perennial Vegetables	Vegetables									
	 Hanging Basket	 Tub or 2-5 gal. Container	 Large Container 8-12 inch pot	 Small Container 4-6 inch pot	 Full Sun	 Part Shade	 Full Shade	 High Yield	 Transplant	 Water Sparingly
Beans (Bush or vine type) (A)		X	X		X			X		
Beets (A)			X		X					
Carrots (A)			X		X			X		
Cucumbers (Bush or vine type) (A)	X	X			X					
Eggplant (A)		X			X			X		
Onions (especially bunching) (A)			X		X					
Peas (Vining) (A)	X		X	X	X					
Peppers (A)		X			X				X	
Radishes (A)			X		X					
Spinach (A)			X	X	X					
Squash (summer & winter types) (A)		X			X					
Swiss chard (A)		X		X	X					
Tomato (A)		X	X		X				X	
Tomato (Cherry) (A)	X	X	X		X				X	
Turnips (A)			X		X					
Lettuce (A)			X	X	X	X				X

**Tips About Vegetables!** Don't Think of Vegetable container gardens as "Plain Janes" that are only sources of food – they can be sources of visual pleasure, too! Brightly colored kale, red leafy lettuce, eggplant and peppers and colorful and beautiful.

**Tips About Vegetables!** To get the most out of your limited space, choose high-yielding varieties. These include beans, beets, carrots, lettuce, peppers, radishes and some varieties of summer squash and tomatoes.

**Tips About Vegetables!** Many vegetables can be grown successfully in 3 to 5 gallon containers, including corn, broccoli,

cabbage, kale, leeks, melons and the new seed-grown potatoes. More new compact varieties are being developed every year.

## Plant selection

During fall and winter, plant double the amount you would during spring and summer, since plants will grow slowly and harvests will be less frequent. Plant what you and your family enjoy eating, and plant enough to meet your family's needs. Choose disease-resistant varieties. Consider maturity dates (early or late season variety), and the size the plant gets relative to the available space. Be sure to select varieties that do well in your growing area. Also try a few new types of vegetables to perhaps discover new favorites. Some crops have short harvest periods, so you can make several successive plantings or choose several varieties to stagger harvests. Planting three weeks apart in spring results in about two weeks' delay in harvest time.

If some of your crops have short growing seasons, you may want to plant more of the same or different crops after harvesting the first.

Vegetables grown from seed will take 4 to 6 weeks longer to mature than those grown from transplants. If you grow your own transplants from seed, start them four to six weeks before the desired planting date.

To discourage soilborne pests, avoid planting the same crop, or crops from the same plant family, in the same place two years in a row. For example, a four-year rotation could include tomatoes, corn, legumes, and squash.

When planting perennials, locate them where they won't be disturbed by the more frequent cultivation, harvesting, and replanting required by annual vegetables.

Plant vegetables to best utilize available space. If you have little space, use varieties that don't become as large as others, or select varieties that can be grown vertically on trellises.



Beets in a raised bed garden. Photo by Kelly Clark, UCANR.

<b>VEGETABLE FAMILIES</b>		
Adapted from George Pessin -- 5/06		
<b>Botanical Family</b>	<b>Common Name</b>	<b>Edible Members</b>
Alliaceae*	Allium or Onion Family	chives, garlic, leeks, onions, shallots
Amaranthaceae or Chenopodiaceae *	Amaranth or Beet family	amaranth, beet, chard, epazote, quinoa, spinach
Apiaceae or Umbelliferae*	Carrot or Dill family	angelica, anise, caraway, carrot, celery, chervil, cilantro, cumin, dill, fennel, lovage, parsley, parsnip
Asteraceae or Compositae*	Aster, Daisy, or Sunflower family	artichoke, chicory, cardoon, endive, escarole, jerusalem artichoke, lettuce, radicchio, shungiku, ( <i>sunflower</i> )
Brassicaceae or Cruciferae*	Brassica, Cabbage, or Mustard family	arugula, bok choy, broccoli, brussels sprouts, cabbage, cauliflower, kale, kohlrabi, mizuna, mustard, radish, rapini, rutabaga, tat soi, turnip
Cucurbitaceae	Cucumber, Gourd, Melon, or Pumpkin family	chayote, cucumber, melon, pumpkin, squash, watermelon
Fabaceae or Leguminosae*	Legume Family	( <i>beans</i> ), fava beans, lentils, peas, peanuts, and soybeans
Lamiaceae*	Mint Family	( <i>basil</i> ), marjoram, mint, oregano, rosemary, sage, thyme
Poaceae or Gramineae	Grass Family	bamboo, barley, corn, rice, rye, sugarcane, wheat
Solanaceae	Nightshade, Potato or Tomato Family	eggplant, pepper, ( <i>potato</i> ), tomato
*Cool weather crop (can be grown through the winter in California) ( <i>Italics</i> ) are contrary to the rule		



## Recommended Vegetable Planting Dates for California

Vegetable	Recommended Planting Dates				General Planting Requirements	
	North and North Coast <sup>a</sup>	South Coast <sup>a</sup>	Interior Valleys <sup>a</sup>	Desert Valleys <sup>a</sup>	Crop Type <sup>b</sup>	Amount to Plant (4 people)
Beans, snap <sup>1,2</sup>	Jul; May-Jun	Mar-Aug	Apr-May; Jul-Aug	Jan-Mar; Aug	W	15-25 ft. row
Beets <sup>1,2</sup>	Feb-Aug	Jan-Sep	Feb-Apr, Aug	Sept-Jan	C	10-15 ft. row
Broccoli <sup>2,3</sup>	Feb-Apr; Aug-Sep	Jun-Jul; Jan-Feb	Dec-Feb; Jul	Sep	C	6-100 ft. row
Cantaloupes, Other melons	May	Apr-May	Apr-Jun	Jan-Apr, Jul	W	5-10 hills
Carrots <sup>1,2</sup>	Jan-May; Jul-Aug	Jan-Sep	Aug-Sep; Feb-Apr	Sep-Dec	C	10-25 ft. row
Chard <sup>1</sup>	Feb-May; Aug	Feb-May	Feb; Aug	Sep-Oct	C	3-4 plants
Chives <sup>1</sup>	Apr	Feb-Apr	Feb-Mar	Sep-Feb	C	1 clump
Corn, Sweet <sup>2</sup>	May-Jul	Mar-Jul	Mar-Jul	Feb-Mar	W	20-30 ft.
Cucumbers	Apr-Jun	Apr-Jun	Apr-Jun	Feb-May	W	6 plants
Eggplant <sup>1,3</sup>	May	Apr-May	Apr-May	Feb-Apr	W	4-6 plants
Garlic <sup>1</sup>	Oct-Dec	Oct-Dec	Oct-Dec	Sep-Nov	C	10-20 ft. row
Lettuce <sup>1,2</sup>	Feb-Aug	Aug-Apr	Aug; Nov-Mar	Sep-Dec	C	10-15 ft row or 5 ft row each month
Okra	May	Apr-May	May	Mar	W	10-20 ft. row
Onions <sup>1,4</sup> (bulb)	Jan-Mar	Feb-Mar	Nov-Mar	Oct-Nov	C	30-40 ft. row
Onions <sup>1,2,3</sup> (green)	Apr-Jul	All year	Aug-Dec	Sep-Jan	C	---
Peas <sup>1,2</sup>	Jan-Apr; Sep-Oct	Aug; Dec-Mar	Sep-Jan	Sep-Oct; Jan-Feb	C	30-40 ft row
Peppers <sup>1,3</sup>	May	Apr-May	May	Mar	W	5-10 plants
Potatoes, sweet <sup>3</sup>	May	Apr-May	Apr-Jun	Feb-Jun	W	50-100 ft. row
Potatoes, white	Early: Feb Late: Apr-May	Feb-May; Jun-Aug	Feb-Mar; Aug	Dec-Feb	W	50-100 ft. row
Pumpkins	May	May-Jun	Apr-Jun	Mar-Jul	W	1-3 plants
Radish <sup>1,2</sup>	All year	All year	Sep-Apr	Oct-Mar	C	4 ft. row
Spinach <sup>1</sup>	Aug-Feb	Aug-Mar	Sep-Jan	Sep-Nov	C	10-20 ft. row
Squash, Summer <sup>1</sup>	May-Jul	Apr-Jun	Apr-Jun	Feb-Mar	W	2-4 plants
Squash, Winter <sup>1</sup>	May	Apr-Jun	Apr-Jun	Feb-Mar; Aug	W	2-4 plants
Tomatoes <sup>1,3</sup>	May	Apr-Jul 15	Apr-May	Dec-Mar	W	6-10 (if processing)
Turnips <sup>1</sup>	Jan; Aug	Jan; Aug-Oct	Feb, Aug	Oct-Feb	C	10-15 ft. row
Watermelons	May-Jun	Apr-Jun	Apr-Jun	Jan-Mar	W	6 plants

<sup>a</sup> North and North Coast = Monterey County north; South Coast = San Luis Obispo County south; Interior Valleys = Sacramento, San Joaquin, and similar valleys; Desert Valleys = Imperial, Coachella valleys. Planting dates are only approximate, as the climate may vary even in small regions of the state. Contact your local Master Gardeners and experiment on your own to find more precise dates.

<sup>b</sup> C = cool season; W = warm season

<sup>1</sup> This crop is suitable for a small garden if compact varieties are grown.

<sup>2</sup> In a suitable climate, these crops can be planted more than once per year for a continuous harvest.

<sup>3</sup> Transplants may be used for planting.

<sup>4</sup> Onion varieties are daylight dependent. Short-day and intermediate-day varieties are autumn planted. Long-day varieties are planted in spring.

Adapted from: *California Master Gardener Handbook, Home Vegetable Gardening*; Dennis Pittenger, editor.

*[This Page Intentionally Left Blank]*

# Getting Started

## *Soil preparation*

### **Soil structure**

Garden soil provides plants with air, water, and mineral nutrients. Soil in good physical condition (good structure or tilth) can hold and provide plant roots with adequate quantities of nutrients, water, and air; it will drain well and be easy to work without becoming sticky when wet or crusted when dry.

Soil alkalinity and acidity is measured on a pH scale, with 7.0 being neutral, below 7 tending toward acidic, and above 7.0 tending toward alkaline. Though different plants prefer different pH levels, most vegetables prefer slightly acidic soils - in the range of 6.2-6.8 pH. Our soil in Northern California is neutral, ranging between 6 and 7pH<sup>1</sup>.

### **Soil texture**

Soil texture is determined by the relative proportions of sand, silt, and clay mineral particles in a given soil. It is one of the most important physical properties affecting plant growth because it determines tilth, as well as nutrient and water-holding capacities. A sandy, coarse-textured soil is often called a light soil, whereas a clay or fine-textured soil is referred to as a heavy soil. These terms reflect the relative ease of working the two soil types.

Soil texture is a good indicator of the soil's physical properties and behavior. With experience, the texture of a soil can be felt and determined simply by rubbing moist soil between thumb and forefinger and noticing its characteristics: how it ribbons, or is pushed out into a thin strip, how it hangs together, and how sticky, smooth, or gritty it is.

The feel method of examining a moist soil gives an approximate measure of particle-size. Coarse and fine sand particles have a marked to moderate gritty feel and do not form cohesive balls. Silt feels smooth when dry and silky (slippery) when wet. Clay soils are sticky and plastic (able to be molded) when wet and hard and compact when dry. Organic matter makes a soil feel smoother, as if it has a higher silt content. The twelve soil textural classes can be grouped into three general texture categories: coarse texture (sandy soils), medium texture (loamy soils), and fine texture (clay soils):

- Coarse (sandy soils): sand, loamy sand
- Medium (loamy soils - moderately coarse, medium, moderately fine)sandy loam, loam, silt loam, silt, clay loam, sandy clay loam, silky clay loam
- Fine (clay soils): clay, sandy clay, silty clay

---

<sup>1</sup> Fabrice DeClerck, Michael J Singer, UC Davis. California Agriculture 57(2):39. DOI: 10.3733/ca.v057n02p39. April-June 2003.

## Determining Soil Texture by the Feel Method

- *Loamy sand, a coarse-textured soil:* A cast will form when moist soil is squeezed in the hand. The cast cannot be handled without breaking; no ribbon can be formed.
- *Loam, a medium-texture soil:* A short ribbon can be formed with moist soil. The ribbon will split readily and will break away when about 1/2" long. A moist cast of a loam soil will bear some handling.
- *Clay loam, a medium-textured soil:* A ribbon can be formed easily in moist soil. This ribbon is moderately strong, but will break away when it is 3/4" long. A moist cast of a clay loam soil will bear moderately handling.
- *Clay, a fine-textured soil:* A strong ribbon can be formed in moist soil. The ribbon often will be more than one inch long. A moist cast will bear considerable handling.

## Effect of Soil Texture on Plant Growth

The coarser the soil texture is, the faster the soil warms up in the spring. A sandy soil may give the gardener a few days advantage in the planting date because of better soil temperature conditions for germination and early seedling growth.

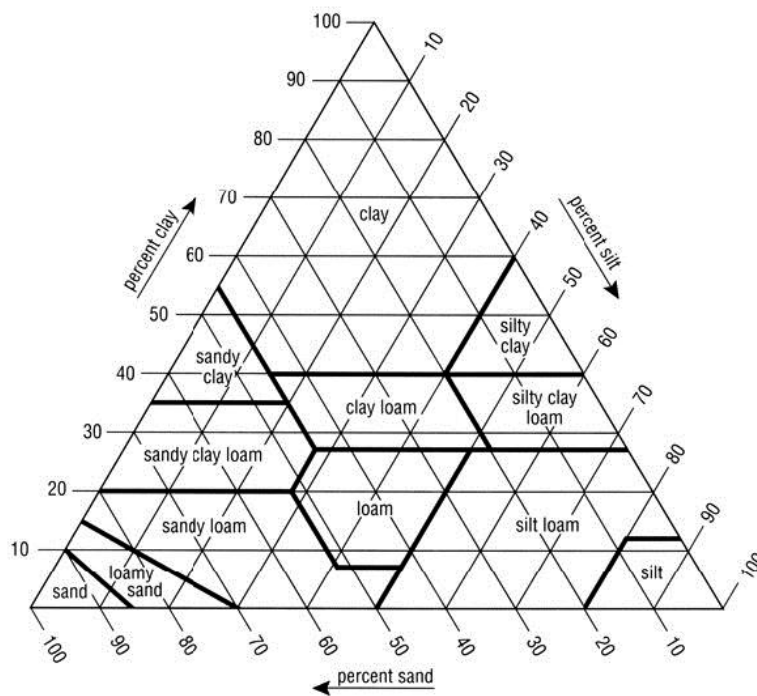

Chart showing the percentages of clay, silt, and sand in the basic textural classes.

Water-holding properties are determined largely by the distribution of particle sizes in the soil. Soils with finer texture (higher percentages of silt and clay) hold more water and nutrients than coarser-textured soils

(higher percentages of sand). Sandy soils have rapid water infiltration and good aeration but low water-holding and nutrient storage capacities. Loam, sandy loam, and silt loam, which contain about 5-10% organic matter are said to be the best soils for home garden cultivation because they provide a mixture of sand, silt and clay that retains sufficient water but also permits infiltration and percolation.<sup>2</sup>

## Trace Elements in Urban Soils

Trace elements occur naturally in all areas and soils of the world. Indeed, some are essential for

2 Adapted from: *California Master Gardener Handbook, Soil and Fertilizer Management*, Dennis Pittenger, Editor.

humans, plants, and animals. We always ingest them to some extent in food and water, and we breathe them in the air. Their concentrations are naturally low and usually not hazardous in non-urban areas with little or no environmental disturbance and past or present human activity. However, any place subjected to human activity is likely to have trace elements at elevated levels in the environment, particularly in the soil. While there is generally no cause for alarm, in some cases, these trace elements may accumulate to a level where it would be advisable to take measures that ensure they will not pose a health risk.

Potentially harmful trace elements, especially heavy metals, can accumulate in the soil and on plants, and may pose a potential health risk to people who breathe or, especially, swallow contaminated soil or eat contaminated vegetables. Although plants always absorb trace elements to some extent, in nearly all instances the quantities they take up are too insignificant to cause alarm. The potential harm is from trace elements deposited on leafy vegetables from dust, splashing water, and the air or are in the soil and cling to root crops like carrots and beets. In these instances, thorough washing of vegetables usually eliminates them. Lead is perhaps the most prevalent and problematic trace element in urban gardens but others, such as cadmium and arsenic, are often present.

### **Testing Urban Soils**

Testing soils in urban gardens is always a good idea. Not only will it reveal which trace elements are present and their concentrations but also where they are located in the garden. An added benefit of testing the soil is the opportunity to gather information about basic nutrient levels at the site. Many companies offer soil-testing services. Sometimes university cooperative extension services can provide you with a list of soil testing companies.

When collecting soil samples it is important to follow the instructions the soil testing company provides. It is a good idea to collect samples from several places at the garden site. For example, if individual gardening beds are 20 by 20 feet it would be appropriate to keep soil from each bed as a separate individual sample. However, several collections from different points in one bed could be mixed together to form a composite sample for that bed.

### **How to Eliminate or Reduce Exposure To Trace Elements**

There is no cause for alarm if tests show that there are concentrations of trace elements above those levels that one would expect in urban soils. There are several procedures that can reduce or eliminate these elements or exposure to them so that they are not harmful.

- Thoroughly remove and properly dispose of refuse from urban garden sites before planting. Be especially vigilant for old painted wood, tires, galvanized metal, and batteries.
- Always wash hands thoroughly after working or playing in urban soils. Thorough hand washing is especially important for children who are more susceptible to trace elements.

Consider using gloves, especially for children.

- Thoroughly wash all vegetables and fruits and peel root crops like beets, radishes, and carrots before eating. Discard older, outer leaves of leafy vegetables.
- Dilute pockets of higher than normal concentrations of trace elements by digging and spreading the soil over a large area in the garden or by adding additional, clean soil and thoroughly mixing it with the contaminated soil. It is generally not feasible to dig contaminated soil from the garden and dispose of it off site. Such soil would be considered toxic waste and strict rules and regulations govern its disposal.
- Since most potentially hazardous trace elements are found in the upper one to two inches of uncultivated or undisturbed soil, it is always a good idea to cultivate soil deeply, to at least eight inches deep if possible, before planting to dilute the contaminated soil with clean soil below.
- Locate plantings, especially leafy crops, as far away as practical from streets. As much as 75 feet would be good. Utilize barriers, such as walls, fences, and hedges, to help to block automobile exhaust and dust from coming into the site from streets and roads.
- Maintain soil pH near 7, or neutral, and ensure phosphate levels are adequate.
- Use large amounts of organic matter, like composts and humus, to amend the soil.
- Mulch with leaves, woodchips, hay, newspaper, or other material to reduce dust.
- Consider planting in raised beds or containers using uncontaminated soil.
- Consider having separate gardening shoes and clothes with long sleeves and pants, especially for children, which are not brought into the house.
- Locate child play sites in uncontaminated areas and/or cover the ground around play areas with an impermeable, artificial play surface, sand, or wood chips.<sup>3</sup>

## Fertilizing

Vegetable crops primarily need nitrogen; they also need phosphorus and potassium. Many California soils are rich in available potassium. Phosphorus levels have been increasing due to the addition of fertilizers.<sup>4</sup> It is best to test your soil before adding products containing these nutrients.<sup>5</sup> Fertilizers come in either organic forms (i.e. manures, composts) or inorganic chemical forms. Often, a combination of the two forms is desirable and gives better results than either one used alone. Organic fertilizers usually provide a number of plant-essential mineral elements in low concentrations along with certain nonfertilizer compounds that aid in improving soil structure. If you use manure,

3 Hodel, Donald R., and Andrew C. Chang, Trace Elements and Urban Gardens, University of California Cooperative Extension: Los Angeles 2007.

4 Fabrice DeClerck, Michael J Singer, UC Davis. California Agriculture 57(2):40. DOI: 10.3733/ca.v057n02p40. April/June 2003.

5 [http://sfp.ucdavis.edu/pubs/Family\\_Farm\\_Series/Veg/Fertilizing/tests/](http://sfp.ucdavis.edu/pubs/Family_Farm_Series/Veg/Fertilizing/tests/)

apply it several weeks or even months before planting and work it well into the soil, allowing adequate time for decomposition and some of the salts to leach from the soil before seeding or transplanting. One pound of dry steer or dairy manure per square foot of soil surface is usually sufficient. If you use the more concentrated poultry manure, apply it more sparingly (1 pound to 4 or 5 square feet). Also, apply commercial nitrogen fertilizer to aid decomposition and avoid tying up soil nitrogen if you use manure that contains litter (straw, shavings, sawdust, or similar materials). Chemical fertilizers are available in a wide variety of compounds and concentrations. If you amend with manure or other organic materials, only inorganic nitrogen fertilizer will be needed. The most common and probably least expensive nitrogen fertilizer suitable for home garden use is ammonium sulfate. Limit application to 1/2 to 1 pound per 100 square feet of soil. If you do not amend with manure or other organic matter, it is usually wise to apply fertilizer that contains both nitrogen and phosphorus before planting, such as ammonium phosphate (16-20-0 or 11-48-0). Commonly used inorganic fertilizers containing potassium include 5-10-5, 5-10-10, 8-16-16, and 12-12-12. Apply 1 to 2 pounds per 100 square feet. Apply fertilizer before or at the time seeds or plants are planted and again when seedlings or plants have grown 3 or 4 inches. If no manure is applied, additional applications of nitrogen are often needed for crops growing longer than four months. Apply fertilizer by broadcasting it or by applying it as a narrow band buried along side of the plant or seed row. If broadcasted, work it into the soil immediately and water the area well. If banded, normal watering will dissolve the fertilizer toward the seed or plant row<sup>6</sup>.

The three most important nutrients in fertilizers are Nitrogen (N), Phosphorus (P), and Potassium (K):

<b>NUTRIENT</b>	<b>PURPOSE</b>	<b>ORGANIC SOURCES</b>	<b>INORGANIC SOURCES</b>
<b>Nitrogen</b>	<b>Promotes healthy leaves and stems; gives rich green color</b>	<b>Blood meal, Worm meal, Cottonseed meal, Manure, Bean and peas, Cover crops</b>	<b>Ammonium sulfate Ammonium nitrate Urea</b>
<b>Phosphorus</b>	<b>Promotes flower/fruit growth and seed formation, plus good stems and roots; necessary for photosynthesis</b>	<b>Bone Meal</b>	<b>Single super phosphate</b>
<b>Potassium</b>	<b>Promotes flower/fruit growth and quality, plus good stems and roots; overall plant health</b>	<b>Sulfate of Potash Magnesia (Sul-Po-Mag) Greensand</b>	<b>Potassium sulfate</b>

## Use of mulch

Most plants, but particularly vegetables, grow best in well-drained soil. A 2 - 4" layer of compost or manure mixed in to a depth of at least 10" will help achieve this. A 3 - 4" layer of mulch or organic matter covering the garden surface throughout the year enables optimum plant and root growth by:

<sup>6</sup> Pittenger, Dennis R. Soil and Water Management for Vegetable Gardens. Riverside, California: University of California Cooperative Extension, 2003.

- reducing crusting and cracking of the soil surface
- holding in moisture
- encouraging earthworms, moderating soil temperatures for optimum root growth, improving the soil as it decomposes
- preventing weeds from germinating

Organic mulches, which include compost, wood chips, grass clippings, rice hulls, bark, straw, sawdust, leaves, and other similar materials, reduce moisture loss. In addition to their value for moisture conservation, they can be tilled into the soil after cropping to improve the organic content. Organic mulches are also helpful in controlling weeds<sup>7</sup>.

Natural inorganic mulches include sand, gravel, and pebbles. They do not provide organic matter for soil, but do conserve moisture. If using a rock mulch, consider placing a landscape fabric underneath to create a layer between the mulch and the soil and prevent rock pieces from sinking into the soil. Black plastic has been used to improve weed control, but it restricts air and water movement. Synthetic mulches, which are manufactured materials that are called geotextile or landscape fabrics, have been developed to replace black plastic in the landscape. Geotextiles are porous and allow water and air to pass through them, overcoming the major disadvantage of black plastic.

Mulch decreases evaporation from the soil by 70% or more; allowing you to water less often. Keep mulch several inches away from tree trunks and plant stems to enable good air circulation. Water well before applying mulch, or you will insulate dry soil rather than moist soil. Let grass clippings dry out a bit before piling them (or just spread them thinly), or they will clump into a mat that stinks and is impervious to later watering.

## Seed starting

Starting vegetable seeds indoors early can reduce the cost of transplants and allow you to grow varieties that may be difficult to find in the nursery as transplants.

To start you will need a soilless mix; growing containers; and the proper moisture, light and temperatures.

Indoors, a south window source of light will work, but rotate the containers so seedlings will grow straight. You can also use two 40-watt cool fluorescent lights suspended about six inches above the plants, moving the lights up as the plants grow. Keep the plants at a fairly warm temperature. Most vegetables germinate best between 65-75° F.

---

7 <http://www.ipm.ucanr.edu/PMG/GARDEN/ENVIRON/mulches.html>



Use a fine-textured, uniform and airy potting mix. Do not use garden soil, as it is too heavy and often carries disease-causing organisms.

The depth of the container should be at least two inches deep and have drainage holes at the bottom. Many small containers can be recycled for seed germination, including egg and milk cartons, plastic soda bottles, and pie pans. If you intend to plant in recycled containers, sterilize them first with a solution of one part bleach to nine parts water. Rinse them well and let them air dry prior to use.

Keep potting mix evenly moist. If you have planted directly into a seed flat, transplant them into larger containers as soon as they have their first true leaves. When they reach two-to-four inches tall, gradually expose the plants to longer periods of direct sun each day to transition them to the outdoors over a period of two weeks.

## Transplanting

Most vegetables transplant well. Exceptions include those with long tap roots like carrots, parsley, and cilantro, and also potatoes and corn, which should be sown directly outdoors where they will mature.

Choose plants in 6-packs and 4" pots. The small plants will quickly catch up. Larger container plants take longer to settle in to their new homes and usually don't bear as prolifically.

To transplant all vegetables except tomatoes:

- Handle small seedlings by their leaves, not their delicate stems.
- Plant seedlings at the same depth they grew in their containers.

For tomatoes:

- Pinch off all but the top several leaves of the plant.
- Dig hole deep enough to plant tomato up to its top leaves.
- Plants will develop roots all along their stems.

For all plants including tomatoes:

- Dig a hole at least 2 inches wider and deeper than the rootball.
- Gently loosen up the outer soil and roots on the rootball to stimulate new growth.
- Firm the soil gently around the plant.
- Water plant 3 times to fully saturate the rootball and surrounding soil. When the first water is absorbed, repeat twice more to thoroughly moisten the surrounding soil.

- Provide shade against late-afternoon sun for about a week.
- Water deeply every other day for about a week.
- After that, water once or twice a week as necessary depending on weather.
- Every two weeks, fertilize with mild, water-soluble fertilizer such as fish emulsion.

## Composting

Composting is a method of producing a nutrient rich soil amendment (plant food) by using naturally occurring beneficial fungi and bacteria to break down organic waste. The simple process of composting allows large amounts of household, yard, and/or animal waste (do not use manure from cats, dogs, etc.) to be transformed into smaller piles of natural soil conditioner. The composting process involves controlled biological decomposition of organic material, sanitization through the generation of heat, and stabilization of the final product to make it beneficial to plant growth. As bacteria, yeast and fungi digest the waste, they make nutrients more available. When compost is added to soil, the nutrients are slowly released over time, allowing easy uptake by plants.

COMPOSTING METHODS		
	Hot	Cold
<b>Microbial Activity</b>	high	low
<b>Brown to Green Waste Ratio</b>	1 to 1	not critical
<b>Processing Time</b>	short	long
<b>Pathogens/Weeds</b>	not a problem	possibly problematic
<b>Pile Turning</b>	1x per day	once every 3 - 6 weeks

There are many ways to make compost: underground, above ground, in bins, in boxes, in pits, in bags, in barrels, in strips, in sheets, and in trenches. The composting process can take as few as fourteen days or as many as fourteen months, depending on the method. Each method has its own advantages, but they all have the same basic requirements: air, moisture, nitrogen, bacteria, heat, sufficient size, and plenty of organic matter. These elements are critical for the compost pile to heat up correctly.

**Hot composting** yields compost quickly, in as little as two weeks, and destroys most pathogens and weed seeds. This process relies on frequent turning of the pile, as often as once a day, to ensure even heating. The carbon-to-nitrogen ratio must be controlled with this technique: this means the composition of the pile needs to be approximately 1 part of brown (high in carbon) material, such as dry grass, dry yard trimmings, leaves and shredded paper, to every one part of green (high in nitrogen) material, including food waste, coffee and tea grounds, fresh cut grass and hair.

**Cold composting** is a much less labor-intensive but more lengthy process, taking three months or longer. Turning is required just once every three-to-six weeks, if at all. Materials can be continually added in layers alternating green and brown to the existing pile. Since high temperatures are not achieved, pathogens and weed seeds aren't reliably destroyed.

Half green (e.g. vegetable scraps, grass clippings), half brown (e.g., leaves, shredded paper). A pile with too much green will smell; a pile with too much brown will take longer to break down. Add a bit of soil to introduce microorganisms that initiate the composting.

Do NOT compost poisonous, diseased, or insect infected plants; weeds, dog or cat manure, meat, fish, dairy products, or anything with fat or oil.

Chop/shred the ingredients into small pieces. The smaller they are, the faster they will break down.

Conditions for standard composting:

- Size: large enough to hold heat, but small enough to allow air to reach the center of the pile - 3' x 3' to 5' x 5'.
- Air: turn the pile every 3-7 days for hot composting and every 3-6 weeks for cold composting.
- Water: the pile should be as moist as a wrung-out sponge.

When is the compost done?

- The pile will shrink, losing about 1/3 of its volume.
- The temperature will drop.
- It will be dark brown and crumbly with an earthy smell.
- You should no longer be able to tell what each of the individual ingredients was.
- Allow compost to age for two weeks before you add it to the soil around plants. Or, incorporate but don't sow seeds or transplant seedlings for two weeks.

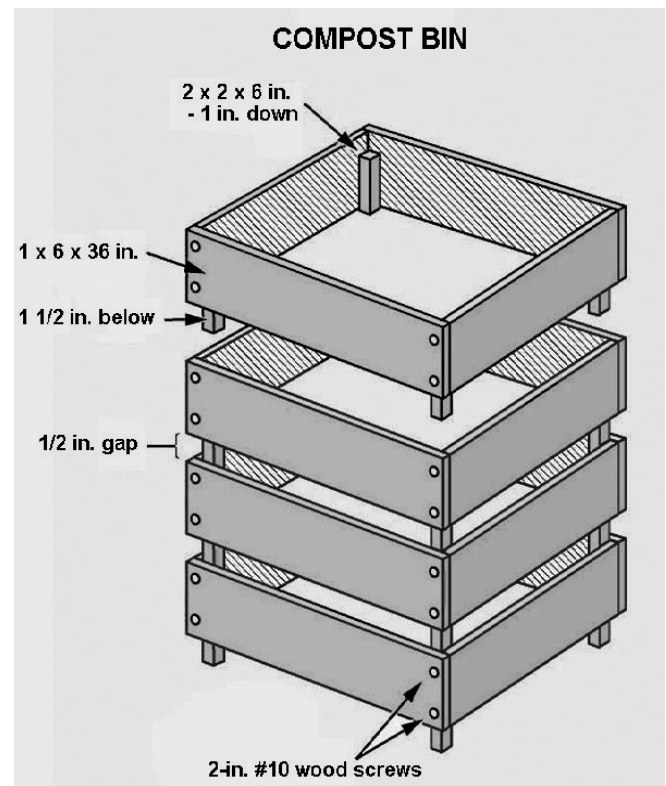

Home-built compost bin designed by Backyard Composter Program, UCCE - L. A. County. ©2001 Regents, Univ. of Calif.

**COMPOSTING SYSTEMS**

<b>Type</b>	<b>Advantages</b>	<b>Disadvantages</b>
Slow outdoor pile	Easy to start and add to. Low maintenance.	Can take a year or more to decompose. Nutrients are lost to leaching. Can be odorous and attract animals and flies.
Hot outdoor pile	Fast decomposition. Weed seeds and pathogens are killed. More nutrient-rich because less leaching of nutrients. Less likely to attract animals and flies.	Requires lots of effort to turn, aerate, and manage the process. Works best when you have lots of materials to add right away, as opposed to a little bit at a time.
Bins and boxes	Neat appearance. Holds heat more easily than a pile. Deters animals. Lid keeps rain off compost. If turned, decomposition can be quite rapid.	Costs you time to build the bins or money to buy them.
Tumblers	Self-contained and not messy. Can produce quick compost. Relatively easy to aerate by turning the tumbler. Odor not usually a problem. No nutrient leaching into the ground.	Tumblers are costly. Volume is relatively small. Works best if material is added all at once.
Pit composting	Quick and easy. No maintenance. No investment in materials.	Only takes care of small amounts of organic material.
Sheet composting	Can handle large amounts of organic matter. No containers required. Good way to improve soil in large areas.	Requires effort to till material into the soil. Takes several months to decompose.
Plastic bag or garbage can	Easy to do year-round. Can be done indoors. Requires no back labor.	Is mostly anaerobic, so smell can be a problem. Can attract fruit flies. Need to pay attention to carbon/nitrogen ratio to avoid a slimy mess.
Worm composter	Easy. No odor. Can be done indoors. Can be added to continuously. So nutrient-rich it can be used as a fertilizer. Good way to compost food waste.	Requires some care when adding materials and removing castings. Need to protect worms from temperature extremes. Can attract fruit flies.

**COMPOST TROUBLESHOOTING GUIDE**

<b>Problem</b>	<b>Cause</b>	<b>Cure</b>
Foul odor.	Too wet.	Mix pile or add coarse, dry material (straw, chips, dry leaves) and mix.
	Not enough air.	Turn pile.
	Too much nitrogen.	Add more brown (high-carbon) materials and mix.
Pile not heating.	Pile too small.	Build larger pile.
	Pile too dry.	Mix pile and add moisture.
	Poor aeration.	Mix pile.
	Not enough nitrogen.	Add more green (high nitrogen) material and mix.
	Materials too coarse.	Chop or shred materials
Pile is damp and sweet smelling but will not heat up.	Not enough nitrogen.	Add more green (high nitrogen) material and mix.
Pile is damp and warm in the middle, but nowhere else.	Pile too small.	Collect more material and mix with old material to make new pile.
Center of pile dry.	Not enough water.	Moisten material while turning the pile.
Pile too hot (over 140° F).	Pile too large.	Make a smaller pile.
	Not enough ventilation.	Mix pile.
Pile attracting animal or insect pests.	Wrong materials used in pile.	Remove all meat and dairy products.
	Kitchen waste on surface of pile.	Bury kitchen waste in pile. May want to cover top of pil with one inch layer of garden soil or finished compost.

## Wise water use

The ideal time to water is before mid-morning. This avoids water waste through evaporation, and enables foliage to dry by sunset, thus precluding disease development.

Fungal diseases thrive when temperatures remain between 70 and 80 degrees; they need only 2-4 hours of moist, warm conditions to develop.

Deep and infrequent watering is important. It is best to water just to the point of run-off, and water as frequently as needed to meet the shovel test (soil should be moist to the base of the shovel when inserted into the soil). Also, if water is running off, you are wasting water. Creating wide watering basins will help guide water to plant roots.

Drip irrigation is a system of applying water to the soil slowly so that waste is minimized. With sprinklers, there may be losses of water outside of the planting area, some runoff if application rates are too high, and evaporation loss to the air. Drip irrigation systems allow water to be emitted uniformly and slowly at the plant location so that essentially all of the water is placed in the root zone.

Most drip irrigation systems should utilize relatively inexpensive cartridge-type filters, as emitters or drip holes tend to become plugged with tiny particles or salts contained in the water supply. Drip irrigation devices range from simple perforated tubes and soaker hoses to sophisticated self-cleaning individual emitters.

One inch of irrigated water will soak down to different depths, depending on how heavy your soil is: 12" deep in sandy soil, 9" deep in loamy soil, but only 3" deep in clay soil. Plant root zones generally reach from 2-12" down, but roots of larger plants like tomatoes may reach 3' down.

Clay soil, because it is so compact, can be watered a little each day for two to three days to enable deep absorption.

- Overwatering is a frequent cause of plant death, since too much water will fill the soil's pore spaces and drown the roots.
- Avoid walking in your garden after watering so that you do not compact the soil. Use stepping stones and straw or mulch paths. Never step into growing-area beds.
- To maintain plant health, overhead water once a week to keep leaves clean.

Two recycling tips:

- Recycle plastic bottles as drip-irrigation containers. Cut off their bottoms, put small holes in the cap, invert, bury, and add water and fertilizer.
- Bury 1-gallon- and 5-gallon-size planting containers almost completely to their rims for easy deep watering with a hose; add a shovelful of manure or compost for feeding every time you water.

# Pest Management

## *Pests in the garden*

When dealing with insects in your vegetable garden, determine acceptable level of infestation - how much damage can your plants withstand before you feel that you must take action? How many chewed or dried-up leaves can the plants stand, and how much yield can you sacrifice before you take measures to curb the population?

This level of tolerance varies from person to person. Some gardeners can't stand the sight of a single creepy-crawly beast or marred leaf, while other gardeners routinely plant extra to accommodate the anticipated loss.

Generally, concerns for the health and safety of our food, the soil, and ground water supplies require that we begin with the least disruptive action, such as blasting pests with jets of water. If the problem persists, apply increasingly destructive methods, such as narrow-spectrum pesticides for specific problems. Take these intermediate steps, rather than turning immediately to the "one spray kills all" approach, because these sprays do kill all: beneficial insects and soil organisms as well as the offending insects.

Less toxic insecticides (insecticides that cause few injuries to people and organisms other than the target pest) listed below should be a first choice when you need pesticides to control insects. Always check product labels to be sure they are registered for your plant or pest situation.

**Insecticidal soaps** (potassium salts of fatty acids) control aphids, whiteflies, and mites; come in easy-to-use squirt bottles for small jobs; and require complete coverage of pests and sometimes a repeat application.

**Insecticidal oils** control aphids, whiteflies, mealybugs, scale insects, spider mites, lacebugs, psyllids, and thrips. Good coverage of plants is required. Don't apply to water-stressed plants or when temperatures are above 90°F. Petroleum-based oil products include superior, supreme, narrow range, and horticultural oils. Plant-based oil products include jojoba, neem, and canola oils.

**Microbial insecticides** are derived from microorganisms that cause disease only in specific insects:

- *Bacillus thuringiensis ssp. kurstaki* (Btk) controls leaf-feeding caterpillars.
- *Bacillus thuringiensis ssp. israelensis* (Bti), sold as mosquito dunks, controls mosquitoes.
- *Spinosad* is a microbial-based insecticide that controls caterpillars, leafminers, and thrips, but it also can harm some beneficial insects.

**Entomophagous nematodes** (*insect-feeding nematodes*) are microscopic worms, mostly *Steinernema* and *Heterorhabditis* species, that attack insects. Use them against lawn insects,

clearwinged moths, and carpenterworm. Because they are living organisms rather than a pesticide, they are very perishable, so order through the mail to assure freshness.

**Botanical insecticides**, which are derived directly from plant materials, vary greatly in their chemical composition and toxicity but usually break down in the environment rapidly.

- *Pyrethrins* (pyrethrum) are used against a range of insects but are toxic to fish and aquatic organisms.
- *Azadirachtin*, from the neem tree, has limited effectiveness against pests but low toxicity to nontargets. Don't confuse with neem oil.

*Garlic, hot pepper, peppermint oil, and clove oil* are sold as insect repellents that protect plants. Little data is available on effectiveness.



Tomato hornworms are easily removed by hand from tomato plants. Photo by Jack Kelly Clark, UCANR.

### **Avoid these more toxic pesticides:**

- Pyrethroids such as permethrin, cyfluthrin, cypermethrin, and bifenthrin move into waterways and kill aquatic organisms.
- Organophosphates such as malathion, disulfoton, and acephate are toxic to natural enemies.
- Carbaryl harms bees, natural enemies, and earthworms.
- Imidacloprid is a systemic insecticide that can be very toxic to bees and parasitic wasps, especially when applied to flowering plants.
- Metaldehyde, a common snail bait, is toxic to dogs and wildlife. Use iron phosphate baits instead.<sup>8</sup>

If the current generation of plants can't be saved, then certainly an improvement can be made for the next, whether in a subsequent planting or in next year's garden. Most vegetables are determined to grow successfully to maturity - to produce foliage, flowers, fruits, and seeds - and then die. This is their natural process, and they will strive to proceed, no matter what. They will be more successful, and you will benefit more, when growing conditions - weather, fertilization, and irrigation - are ideal. To what degree plants achieve this goal depends on the quantity and timing of these elements, whether provided by nature or by the gardener. How the conditions in your

<sup>8</sup> Adapted from *Less Toxic Insecticides*, U.C. Agriculture and Natural Resources Integrated Pest Management: <http://www.ipm.ucanr.edu>, March 2010



garden are altered for better or worse will affect whether your plants thrive, barely exist, or die. This, in turn, will determine their vulnerability to diseases and pests and the quality of the produce you harvest. Healthy gardens make healthy plants, and healthy plants ward off diseases and pests more successfully than unhealthy ones.

The most important means of combatting pests and diseases is through using good cultural practices. Thorough preparation of the soil before planting or sowing is necessary. Incorporating well-rotted manure, a balanced fertilizer, and compost will ensure that plants are given a good start in nutrition and proper drainage that will last through harvest. Additional compost or other organic mulches applied to the soil surface will help to retain soil moisture, provide further nutrients, and suppress weeds. Finally, watering appropriate amounts at appropriate times will aid in reducing pests.

## *Beneficial insects and other biological controls*

Beneficial insects are insects that help limit pest damage. They reduce pest populations primarily by parasitizing or eating pests or weeds. Planting a variety of flowers, vegetables, and herbs will provide food and protection for beneficial insects as well as a conducive environment for reproduction. Providing this variety will also confine pests' searching for their favorite crops.

The two families of flowers that attract the most beneficial insects are:

- Umbelliferae, which have many tiny flowers arranged in tight umbels. These include anise, carrot, caraway, coriander, dill, fennel and parsley.
- Compositae, which have central disc flowers surrounded by many ray petals like a daisy or sunflower. These include black-eyed Susans, goldenrod, and strawflower.

Try using other biological controls as well:

- Plant mustard flowers to attract lacewings (for aphids) and parasitic wasps (for cabbage caterpillars and coddling moths).
- To control white flies on tomatoes, try interplanting them with french marigolds or nasturtiums.
- Encourage birds into your garden to eat the harmful insects by providing whole sunflower seedheads. Hang these on clothes hangers around your garden.



UC Statewide IPM Program  
© 2003 Regents, University of California  
Adult convergent lady beetle feeding on aphids. Photo by Jack Kelly Clark, University of California

- Interplant cucumbers and beans to repel cucumber beetles and prevent the wilt diseases they carry. Also plant Cucurbita lagenaria gourds as trap plants for cucumber beetles.
- Plant potatoes to repel squash bugs.

Here are a few natural enemies to encourage in your garden:

- Convergent lady beetles: used for aphid control.
- Brown Lacewings: often used to control mealybugs, psyllids, thrips, mites, whiteflies, aphids, small caterpillars, leafhoppers, and insect eggs.

For more information on biological controls and natural enemies, please visit <http://www.ipm.ucanr.edu/PMG/NE/index.html>.

## Pest triangle

Disease, insects and weed seeds are always present in garden locations. All these infectious triangle components must be present in order for one of these pests to become established.

**Diseases:** The likelihood of disease is less if the plants are resistant varieties, the wrong life stage, or spaced far enough apart for good air circulation.

**Insects:** The likelihood of pests will be less if the plants are healthy, slow-growing, and spaced far enough apart for good air circulation.

**Weeds:** The likelihood of weeds germinating is less with a 3"-4" layer of organic mulch.

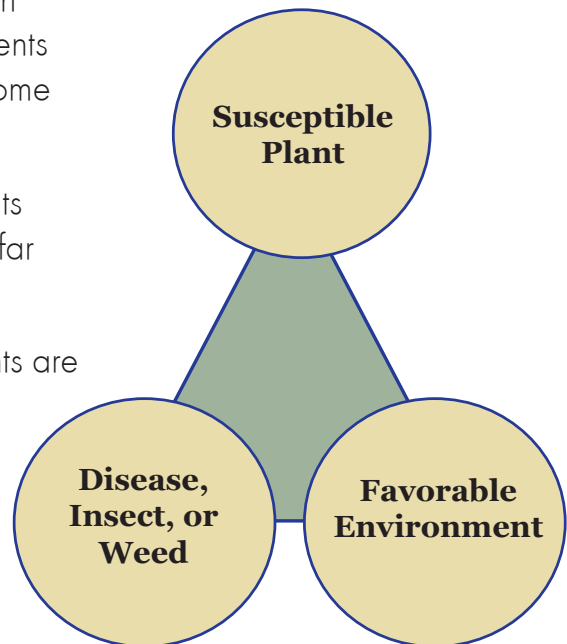

## Weeds

Weeds compete with crop plants for sunlight, water, and nutrients, so their growth must be limited to obtain a reasonable yield of any food crop. In vegetable planting, weeds can quickly shade out young crop plants as well as rob the soil of nutrients and water, so weed control is essential, especially when the crops are young. However, many weedy species can provide benefits in the garden or farm such as providing food and shelter for insect predators and parasites. Before you plant, prepare the soil to encourage a healthy, vigorously growing crop. The primary methods

for weed control in vegetable plots include prevention, hand weeding, mulching, solarization, and - only as a last resort - herbicides.



Common Groundsel (*Senecio vulgaris*) is a common garden weed.  
Photo by Jack Kelly Clark, UCANR.

<http://ipm.ucanr.edu/PMG/menu.homegarden.html>.

Soil solarization is an excellent method for reducing some weed seeds and soilborne diseases. Solarizing involves leaving a clear plastic tarp on the soil surface for 4 to 6 weeks during the hottest part of the year. Soil solarization works well in warm growing areas and may be ineffective in foggy, low-light, or low-temperature areas.

To reduce annual weeds, irrigate the area after final grading to encourage weeds to emerge. While the weeds are still small, scrape the weeds away. Then repeat this process three times. For more information, visit

## Diseases

Disease pathogens are naturally always present in the air and soil. These pathogens become problematic only when all elements of the pest triangle are present. To avoid this, make sure your garden environment does not encourage favorable conditions for disease by collecting and destroying all leaves affected by diseases and fungus, such as peach-leaf curl, roses with blackspot, squash with powdery mildew, and hollyhocks with rust. Do not compost these leaves or use them as mulch, as this will spread the diseases.



Powdery Mildew fungus. Photo by Jack Kelly Clark, UCANR.

## Insects

- To discourage snails and slugs: pick and squish, put beer bait in saucer, collect under board, use copper collars, surround area with the spiky fruit pods of the sweet gum tree, use abrasive surfaces such as egg shells, lift vine vegetables up on cans, fence out with aluminum screening, use trellises to keep foliage off the ground.
- Cover young cole crops with spun-bonded-type row covers to protect them from cabbage moths.
- Wash both sides of plants' leaves, as many pests lay eggs on undersides.
- Aphids, mealybugs, and scale can be dispensed with a strong blast from the hose (support the branch with one hand), or rub them off with a gloved hand. Start doing this when plants are young.
- Red spider mites thrive in hot, dry weather. Hose them off of roses, evergreens, shrubs and ivy. Be sure to thoroughly rinse the undersides of leaves.
- Hand-pick tomato hornworms. Sprinkling the plants lightly with water will make the hard-to-see ones wiggle. Adult hornworms are the larval form of large mottled gray or brown sphinx moths that hover near tubular flowers at dusk in late summer. As you work your soil prior to planting, destroy their pupae - the hard, brown, two-inch spindle shaped cases that are buried 3 - 4" underground.



Variegated cutworm larva. Photo by Jack Kelly Clark, UCANR.



Damage to lettuce leaves caused by insects. Photo by Jack Kelly Clark, UCANR.

# Harvesting

Harvesting time is based on personal preferences. "Gourmet" or "baby" vegetables are merely vegetables harvested when they're small. Blossoms (e.g., squash blossoms) can be harvested for use in salads or other recipes.

Harvest vegetables as early in the day as possible, especially if they are not to be eaten that day or will be refrigerated. As soon as the sun hits the vegetables, the pulp temperature begins to rise. For every 5 degree decrease in pulp temperature when picked, vegetable shelf life will increase 3 more days. Tomatoes, in particular, develop chilling injury (mushy texture and loss of flavor) when they are cooled after being harvested when warm; this is why they should not be refrigerated.

Lettuce and leafy vegetables can be harvested a few outside leaves at a time, leaving the center of the plant to continue to grow for additional harvest every week or so.

Keep vegetables picked often. Vegetables that aren't harvested soon enough will produce a chemical that inhibits further blossoming. Check plants at least every other day during the summer.



Freshly harvested cauliflower and carrots. Photo by E. Kilmartin, UCANR.

Harvest only what will be eaten in the next day or two. Removing mature vegetables from the plant encourages the plant to set additional blossoms and bear more vegetables.

If you have kept plants well-picked, but fruit set has stopped, suspect hot weather. Fruit set will begin again about 10-14 days after the temperature stays below 85-90 degrees.

Toward the end of the summer; pinch off the last blossoms of eggplants, peppers, melons, squashes and tomatoes. This will redirect plant energy to maturing vegetables that have already set instead of setting more fruit that won't ripen before fall cold weather.

## Food safety in your home vegetable garden<sup>9</sup>

From garden to kitchen, there are many chances for bacteria, viruses, and parasites to contaminate produce. Water, tools, animals, and manure-contaminated soil may spread harmful organisms in your garden.

### Clean Soil

- For greatest safety, do not use manure when growing leafy vegetables or other commodities that will be eaten raw.
- Do not add fresh manure to existing compost piles.
- Keep wild and domestic animals out of the garden.

### Clean Hands

- Use protective or disposable gloves when working with manure and compost.
- Always wash hands thoroughly before and after working with these materials.

### Clean Surfaces

- Before and during harvest use clean tools, gloves, harvest containers, and work surfaces.
- Hose off tools, shoes, or boots in an area well separated from your vegetable garden.
- Diluted bleach (1 teaspoon in 4 cups water) or pure white vinegar is safe for sanitizing work surfaces.

### Harvest

- Wash hands before handling produce.
- Use clean harvest aids (tools, bins, gloves).
- While in the garden, remove excess soil from produce.
- Handle produce carefully to avoid bruising and damaging.

### Postharvest Handling

- Wash hands before handling produce.
- Use tap water for all washes.
- Remove soil and potential contaminants by washing with a clean brush under running tap water rather than batch-washing in a basin.
- Diluted bleach (1 teaspoon in 4 cups water) or pure white vinegar is safe for sanitizing work surfaces.
- Always cover and refrigerate cut fruit and vegetables when preparing them in advance.
- Throw out cut fruit and vegetables if they have been held for longer than 2 hours at room temperature or longer than 1 hour at temperatures above 90°F (32°C).



<sup>9</sup> Geisel, Pamela M. and Donna C. Seaver. *Food Safety in Your Home Vegetable Garden*. Davis, CA: University of California Agriculture and Natural Resources, 2009.

# Appendix

## Principal Parts of a Vascular Plant<sup>1</sup>

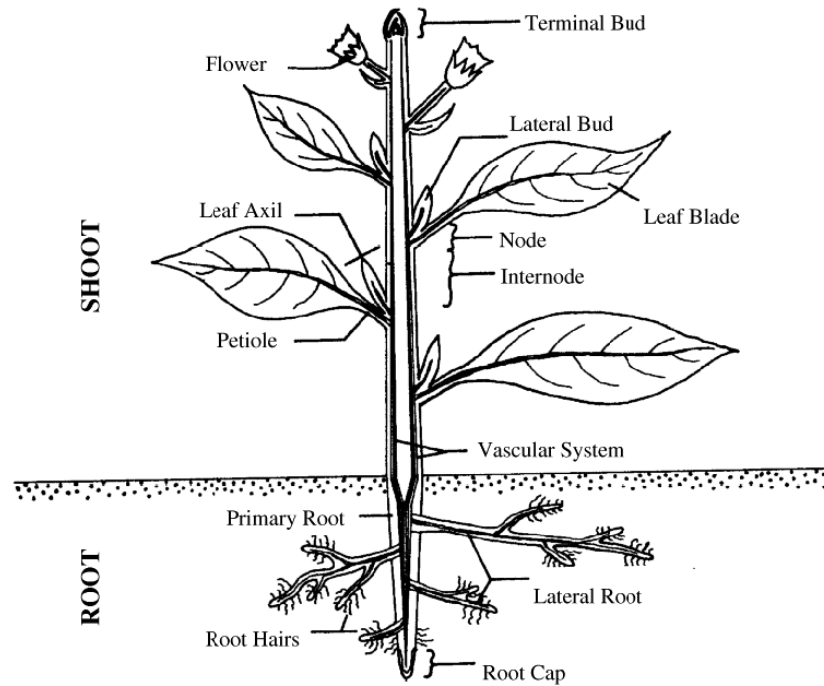

### The Root

The first root to develop is the **primary root**. The **lateral roots**, or secondary roots, branch off from the primary root. **Root hairs** are finger-like extensions that enlarge the root's surface area. Plant roots have several functions: they absorb water and minerals from the soil and transport them; they provide support by anchoring the plant in the soil. Roots also help store food. The outermost tip of the root is the **Root Cap**, which covers and protects the meristem and also senses gravity and directs in what direction the root grows.

### The Shoot

The shoot is composed of three parts: the stem, the leaves, and the flowers. The stem bears leaves and is divided into nodes and internodes. The leaves come from the stem at the nodes. The portion of the stem between the leaves is called the internode.

### The Leaves

Leaves have stomates on their undersides. these port-like openings regulate the water in plants by opening and closing. Stomates do occur on the upper surfaces of many leaves and along stems but are found more so on the undersurfaces of the leaves.

### The Stem

The stem provides support for the plant. Its internal tissues - phloem and xylem among others, move water and minerals upward from the roots to the leaves and photosynthates down from the leaves to the roots.

<sup>1</sup> Adapted from <http://ag.arizona.edu/pubs/garden/mg/botany/plantparts.html>. © 1998 The University of Arizona.

# Principal Parts of a Flower<sup>1</sup>

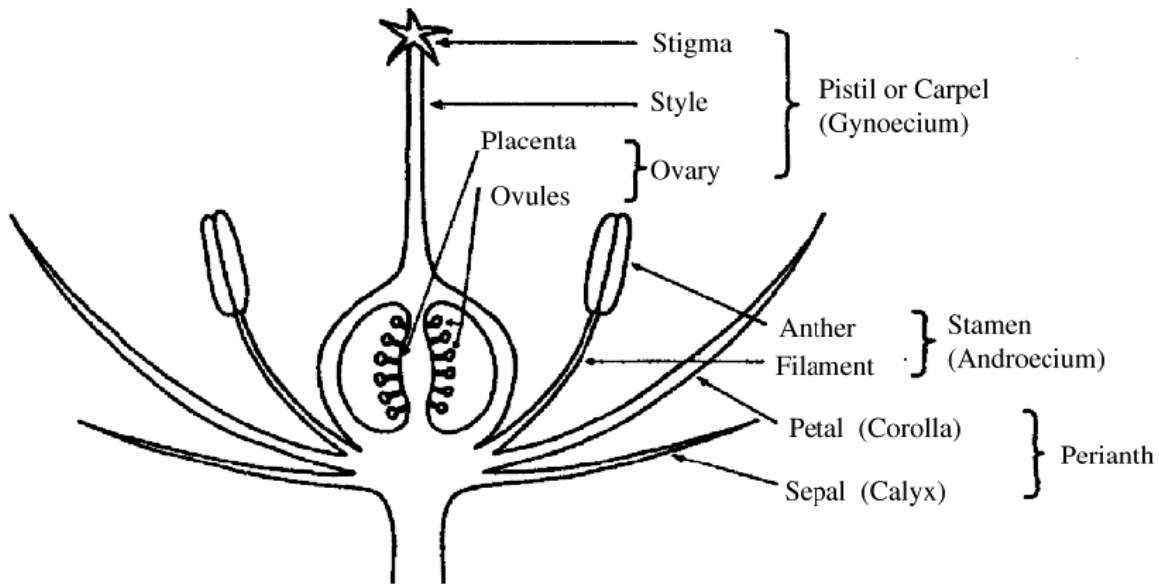

## Petals

Petals attract insects with their colors. These help in pollination.

## Sepals

Sepals are small green, leaflike structures on the base of the flower which protect the flower bud. The sepals collectively are called the **calyx**.

## Male Flower Parts

The **stamen** is the organ that produces pollen. The **filament** is a thin long stem that supports the anther with its pollen. The **anther** produces the grain pollen.

## Female Flower Parts

The **pistil** is located in the center of the flower. The **stigma** receives the pollen. It can be feathery, sticky, hairy, or shaggy. The **style** acts like a passageway for pollen to reach the ovary. The **ovary** is where seeds develop. The **ovule** is located inside the ovary and contains immature seed.

<sup>1</sup> Adapted from <http://ag.arizona.edu/pubs/garden/mg/botany/plantparts.html>. © 1998 The University of Arizona.



# Garden Chemicals: Safe Use & Disposal

Pesticides (insecticides, herbicides, and fungicides) are designed to be toxic to the pests they target. When used properly, pesticides can protect your plants or home from damage. However, when the label instructions aren't followed correctly, plant injury can occur, pests might not be controlled, human health might be impaired, and pesticides can contribute to soil, air, or water pollution. Fertilizer products also can have negative environmental impacts when they get into waterways. Use pesticides only when nonchemical methods are ineffective and pests are reaching intolerable levels. Choose the least toxic, most effective product.<sup>1</sup>

If you must use garden chemicals:

- Identify your pest problem and choose the least toxic pesticide that controls your pest. Examples include bait stations, insecticidal soaps and oils, and microbial insecticides.
- Contact your UC Master Gardener or Cooperative Extension office for help identifying your pest or a pest control method.
- When possible, buy ready-to-use products rather than concentrates.
- Don't water after applying garden chemicals unless the labels tells you to do so. Never let pesticide or fertilizer runoff flow into storm drains.
- Avoid applying chemicals outdoors when rain is forecast or when it is windy.
- Don't apply pesticides or fertilizers on paved surfaces.

When using and storing garden chemicals:

- Always wear shoes, a long-sleeved shirt, pants, eye protection, and other equipment required on the product label.
- Properly measure concentrated formulations of pesticides. Keep all measuring tools for the garden separate from those used for food.
- Never apply more product than the amount listed on the label.
- Always keep chemicals in their original container and store them tightly capped in a locked cabinet out of the reach of children and pets.
- For help in an emergency call your regional Poison Control Center at 1-800-222-1222. Visit <http://www.calpoison.org> for more information.

Disposing of pesticides and fertilizers:

- Sewage treatment plants aren't designed to treat for toxic chemicals. Pouring garden chemicals into a storm drain, down the sink, or in the toilet is never an option—and it is against the law!
- The only allowable way to dispose of pesticides is to use them up according to label directions or to take them to a household hazardous waste site.

---

<sup>1</sup> Adapted from *Garden Chemicals: Safe Use and Disposal*, UCANR Integrated Pest Mgmt. January 2003.

*[This Page Intentionally Left Blank]*

# Resources

## **UC Master Gardener Program of Contra Costa County**

<http://ccmg.ucanr.edu>

- Seasonal Gardening Tips
- Seasonal Activity Checklist
- Information on composting, container gardening, recycling, tools, etc.

## **Other UC Websites**

- Agriculture and Natural Resources Publications Catalog <http://anrcatalog.ucanr.edu/>
- Fruit and Nut Research Center - <http://fruitsandnuts.ucdavis.edu/>
- Backyard Orchard - <http://homeorchard.ucanr.edu/>
- Integrated Pest Management - <http://www.ipm.ucanr.edu/>
- Small Farm Program - <http://sfp.ucdavis.edu/crops/>
- Vegetable Research & Information Center - <http://vric.ucdavis.edu>

## **Websites of Interest: science-research-based information on different gardening topics**

- General Gardening
  - \* National Gardening Association - <http://garden.org>
  - \* Contra Costa Water District Water Conservation - <https://www.cewater.com/148/Conservation>
  - \* WaterSmart Gardening - <https://www.ebmud.com/water/conservation-and-rebates/watersmart-gardener/>
- Community Gardening
  - \* American Community Gardening Association - <http://www.communitygarden.org/>
- Fruit and Nut Growing
  - \* University of California Fruit and Nut Research and Information Center - <http://fruitsandnuts.ucdavis.edu>
  - \* California Backyard Orchard - <http://homeorchard.ucanr.edu>
  - \* California Rare Fruit Growers - <http://www.crfg.org>

- *Pest Management*
  - \* *University of California Statewide Integrated Pest Management Program* - <http://www.ipm.ucanr.edu>
  - \* *California Invasive Plant Council* - <http://cal-ipc.org>

*[This Page Intentionally Left Blank]*

